

**CREATE YOUR OWN
MONSTER**
FRANKENSTEIN
Made with Pride **TRIKES** Pleasanton, KS, U.S.A.

Installation Guide

Softail

38" Sport Trike Kit

All Years



INCLUDED IN YOUR TRIKE KIT:

COMPONENTS

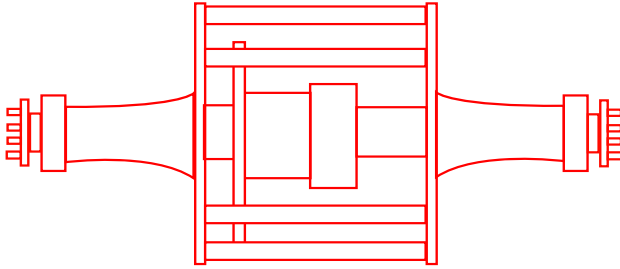

Frankenstein Trikes Rear End

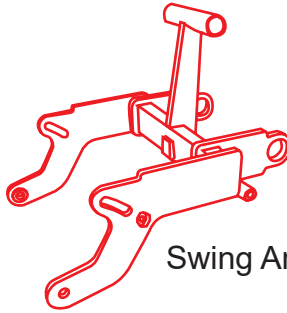

Swing Arm

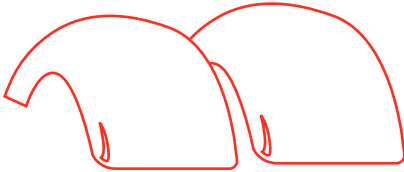

2 Sport Fenders

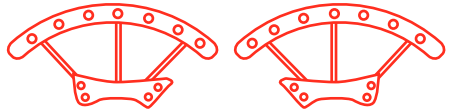

2 Fender Brackets

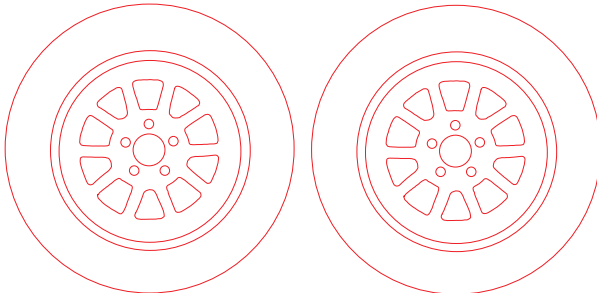

2 lon 15" X 8" wheels style 171-5865-P

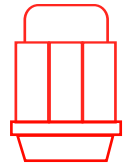

10 lug nuts

1 2 Center caps and 2 General Altimax 215/60R15 tires

HARDWARE

PULLEY MOUNTING

- 5 pcs. - 7/16" -14 x 2" Grd. 8 (Gold) Bolt ('00 & up)
- 5 pcs. - 7/16" -14 x 1 1/2" Grd. 8 (Gold) Bolt ('99 & down)
- 5 pcs. - 7/16" Lock Washer

FENDER MOUNTING

- 14 pcs. - 3/8" - 16 x 1" Grd. 5 (Zinc) Bolt
- 14 pcs. - 3/8" I.D. 1" O.D. 1/16" Thick Grd 5 Washer
- 14 pcs. - 3/8" -16 Nylock Nut

***NOTE!** Additional hardware used to mount fender brackets to the rear end are pre-installed onto the rear end.*

WHEEL MOUNTING

- 10 - Lug Nuts



LOCTITE is included with every kit and must be used where instructed in this manual.

STAGE 1. Motorcycle Preparation:



Always refer to your Harley-Davidson owners manual before performing any work on your bike.

1. Secure front wheel so motorcycle won't tip, set jack under the motorcycle and raise the jack to take the weight off of the rear wheel.
2. Remove factory exhaust. If you have short exhaust you can leave them attached.



Factory exhaust will not work when converting your bike to a trike.

3. Remove upper and lower belt guards.
4. Loosen axle adjusters on both sides.

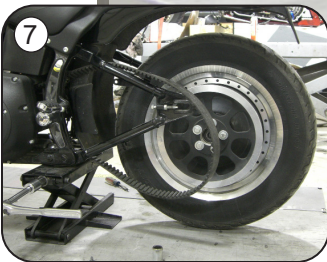
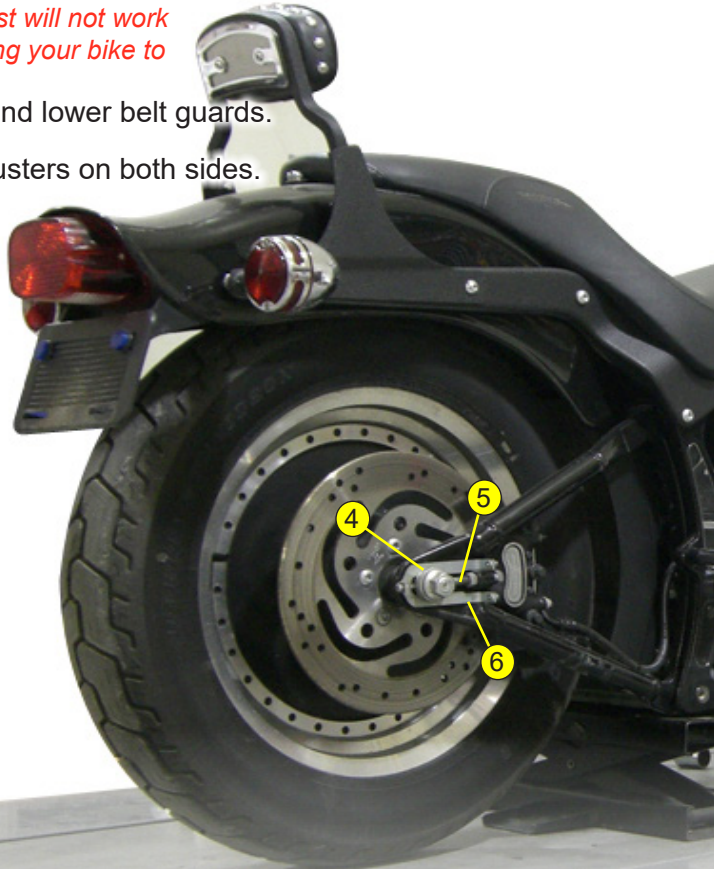

5. Remove axle nut.

6. Remove axle from wheel and swing arm.

7. Slide the belt off of the pulley.

8. Remove the banjo bolt that holds the rear brake line to caliper, hang brake line out of the way.

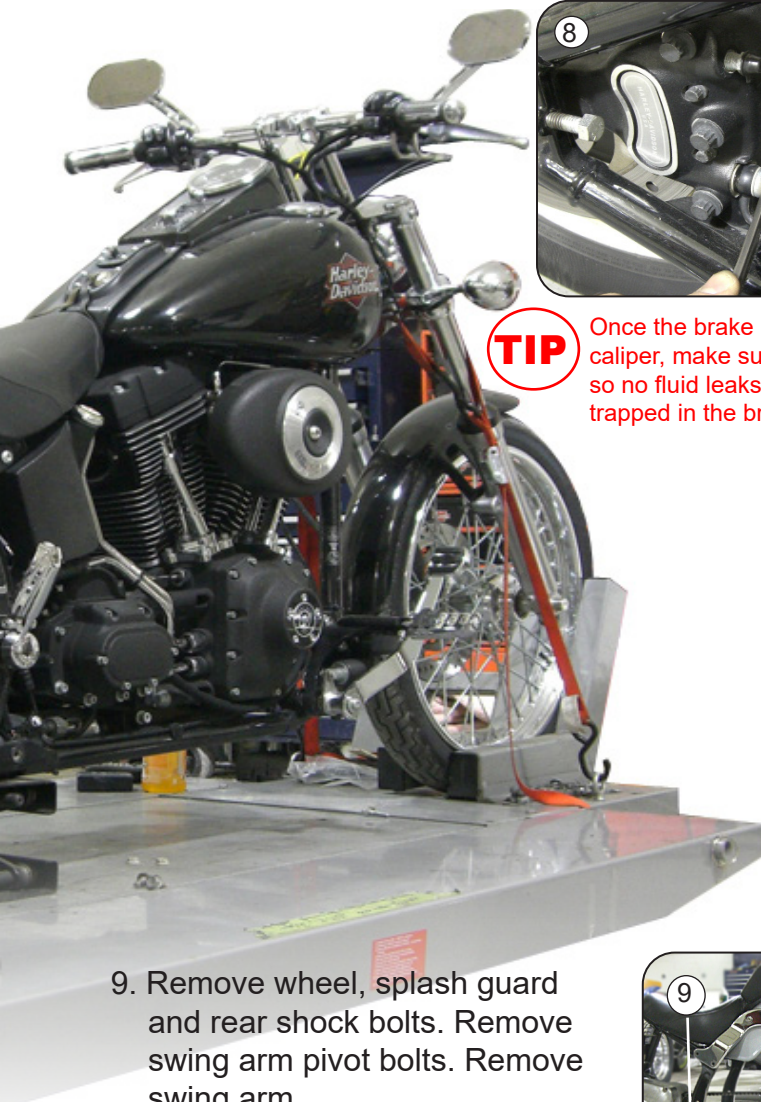

TIP Once the brake line is unhooked from caliper, make sure to hang line upright so no fluid leaks out and no air gets trapped in the brake line.

9. Remove wheel, splash guard and rear shock bolts. Remove swing arm pivot bolts. Remove swing arm.



TIP Now would be a good time to check the condition of your pulley and belt.

STAGE 2. Rear End Preparation/Installation:

★ 38" and longer rear ends are shipped with one or both axles not installed in the rear end. To install axles, remove the axle retainer plate (see diagram 10 pg. 7) and insert axle. Reinstall bolts, loctite and torque to 31 ft. lbs.

1. With swing arm and rear wheel removed, have a friend help set a wheel and tire on the brake side of the rear end. Install with lug nuts.

TIP Install center cap into wheel before mounting.

2. Set the rear end on the wheel that was previously installed. Remove the five bolts to the spokes, Remove axle, axle housing and star plate as a unit.



Do not remove green tape, it will be used as a reference point in the following instructions.



3. If you have a 1999 and earlier Softail with a pulley or sprocket that has a center hole with a diameter of approximately 1.980" (50.292mm) then your pulley or sprocket will need to be machined. Install tool as shown using supplied bolts. Place back side of tool onto lathe chuck. Use boring tool to expand the diameter of the center hole. Measure frequently while boring until the diameter of the center hole is 2.212" (56.185mm). If your Softail is 2000 and later go to next step.

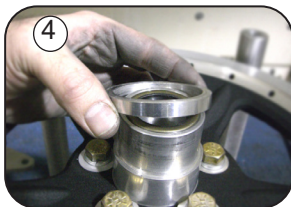

shown '00 and up

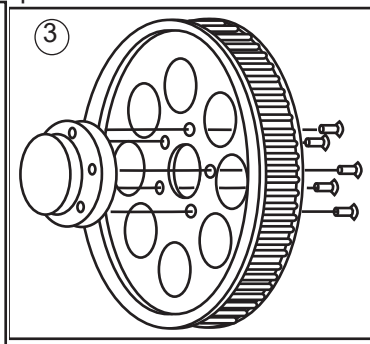
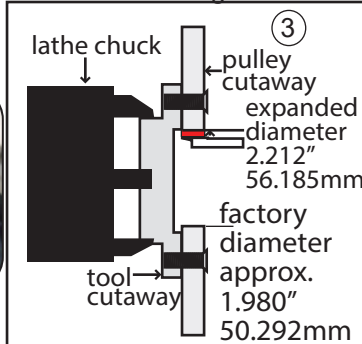

4. Install Pulley. Install 7/16" pulley bolts with lock washers provided apply **red loctite** and torque the pulley bolts. Have friend help hold the center section of the rear end with a screw driver through a hole in the rotor through and one of the holes in the star plate. Torque the pulley bolts to 65 ft. lbs. Insert spacer

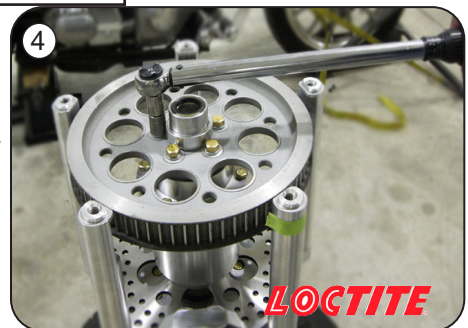

5. Install trike swing arm use your bolts, spacers and pivot tube. Do not bolt up shocks, let swing arm hang down by spreading shocks a little bit, swing arm will hang down more. Torque swing arm pivot bolt.

Torque Specs:	'99 and down 120-150 ft. lbs.	2000 and up 90-110 ft. lbs.
----------------------	-------------------------------	-----------------------------



6. Prepare a Block and position rear end as shown below.

7. Slide the rear end under the bike. Lower the jack and set belt on pulley. (This is a little tricky but have patience) This is shown with a 65 tooth pulley. For a larger pulley you may need to loosen the spokes on the opposite side of rear end to accommodate the belt installation. You may have to work around each spoke spreading then inserting belt while lifting the axle.

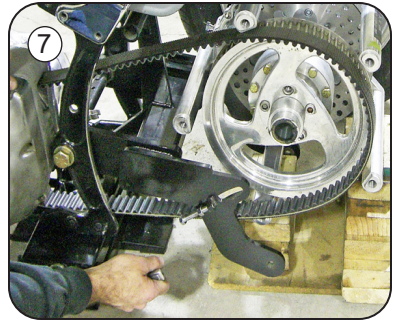

8. Slide drive side star plate onto rear end differential housing, align the star plate with the spoke that was marked with the green tape. Start all 1/2" allen bolts on star plate into spokes, tighten evenly. Use blue loctite. DO NOT FORCE BOLTS IN

9. On Brake side - Remove the 1/2" allens one at a time apply blue loctite and reinstall, torque 60 ft. lbs. Repeat on pulley side. Do not loctite Gold colored bolts at this time they will be removed to install fender brackets.



10. Install lower swing arm mounting bolts both sides, leave loose. Install upper swing arm mounting bolts, make sure to put the 1/4" thick washer between the swing arm and the star plate on both sides, leave loose. Refer to diagram for placement of washers and spacers.

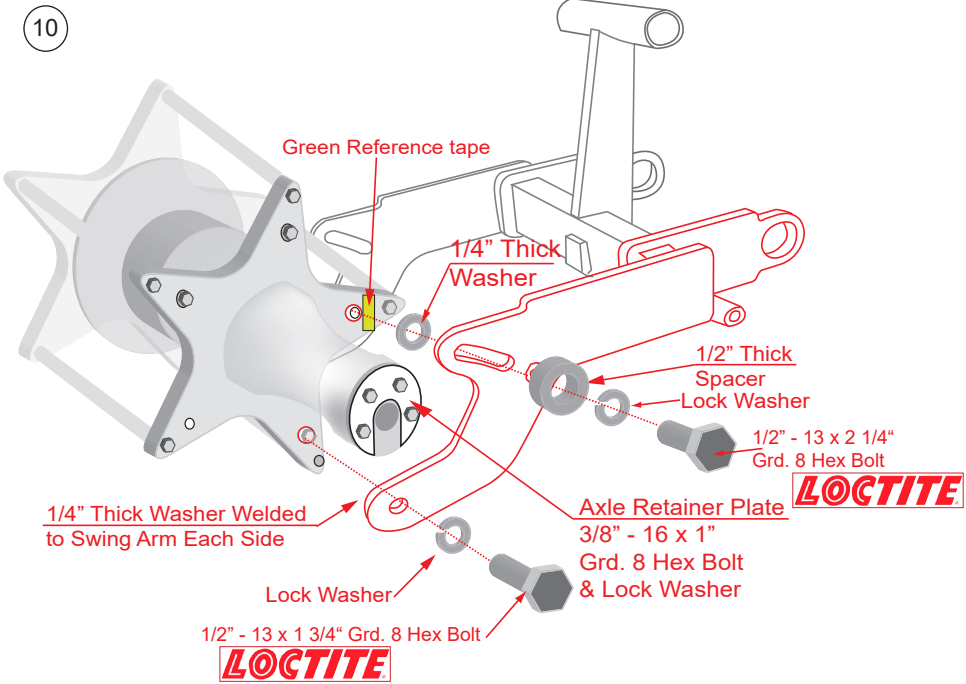

11. Raise or lower the jack to install shock bolts and torque 115 to 130 ft. lbs.
12. Install wheel and tighten lug nuts.
13. Install brake line to rear caliper and bled.



14. Adjust belt tension to factory specs.

⚠️ *The trike must be sitting on the ground on its suspension to adjust the belt.*

15. Tighten jam nut on adjuster bolts.

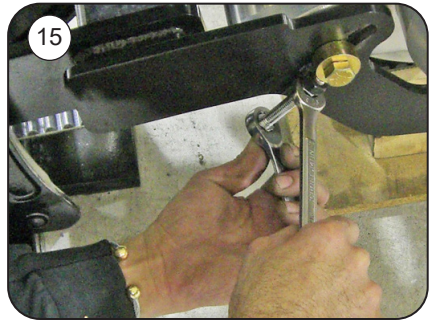
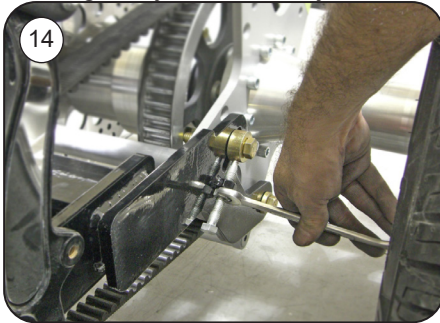

16. Torque the four rear end mounting bolts to 60 ft. lbs.

⚠️ *The trike must be sitting on the ground on its suspension to adjust the belt. Shown without wheel and on blocks for photography.*

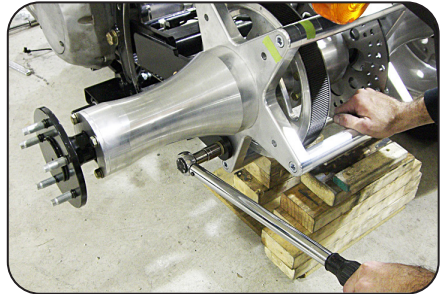
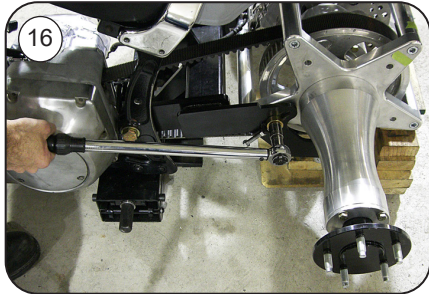

Shown with axle and wheel removed & FL Style One piece Fender Bracket

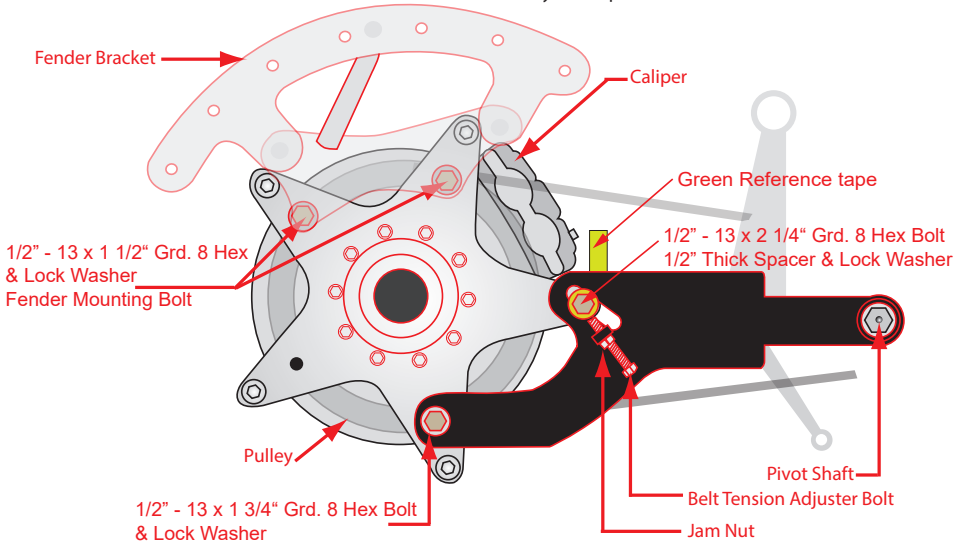

17. Attach fender brackets to fenders using supplied FENDER MOUNTING HARDWARE ★ *Note: side with more space from bolt holes to edge of fender goes toward the front.*

18. On 2 piece Fender brackets. Remove top two star plate to spoke bolts and two bolts just below bolts previously removed, on one side at a time. Install fender and bracket on the rear end. Apply blue loctite. Install top two star plate bolts and lower mounting bolts. Install fender and fender bracket on other side as previously described. Torque upper fender bracket bolts to 60 ft. lbs. Torque lower fender bracket bolts to 60 ft. lbs.

18 shown: left bracket and fender

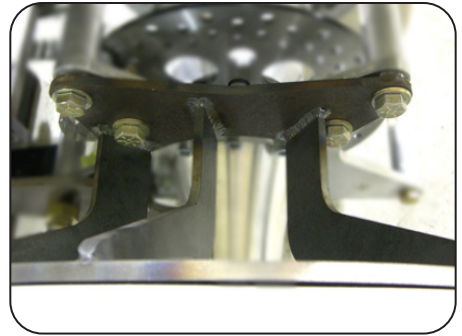
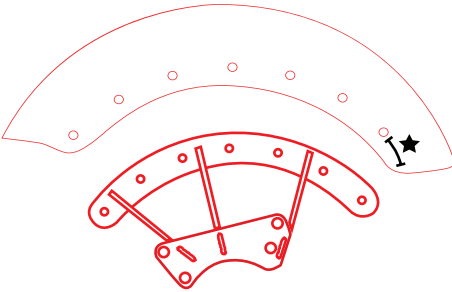

★ *Note: side with more space from bolt holes to edge of fender goes toward the front.*

19. We have included a strap to reduce vibration. Please install the strap on both fender brackets as shown in this illustration. (please note this is only used on kits with 15x8 wheels and 215/60/15 tires with two separate fender brackets)

Install strap in the third bolt position from the front. Use Loctite on bolt to secure gold thin nylock nut. Thick side of strap attaches to the star plate on the rear end, narrow end of strap attaches to fender.

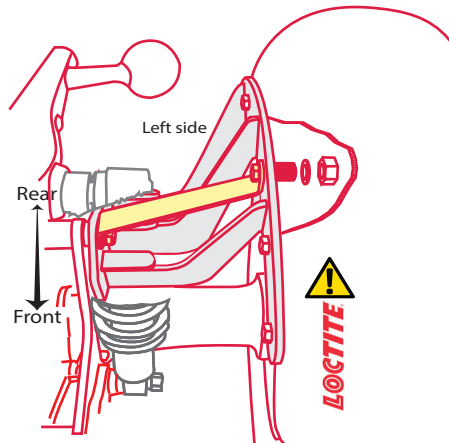

Depending on your kit you may have the long FL style Fenders.

20. Attach fender brackets to fenders using supplied FENDER MOUNTING HARDWARE. See diagram for proper installation.

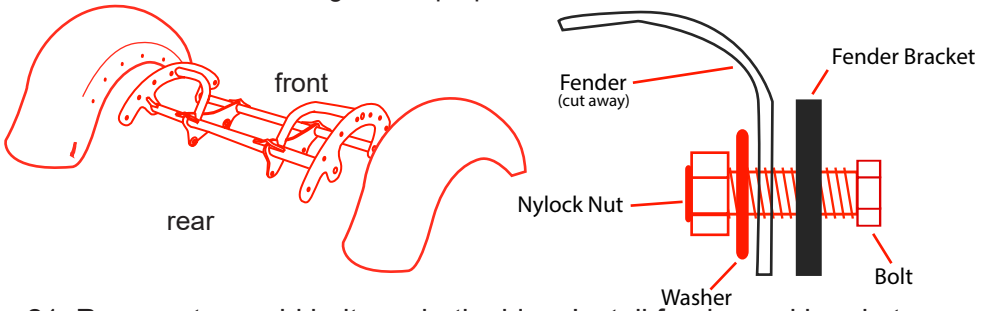

21. Remove two gold bolts on both sides. Install fender and bracket on the rear end. Torque fender bracket bolts to 60 ft. lbs.

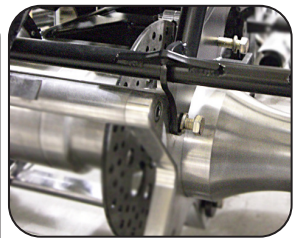
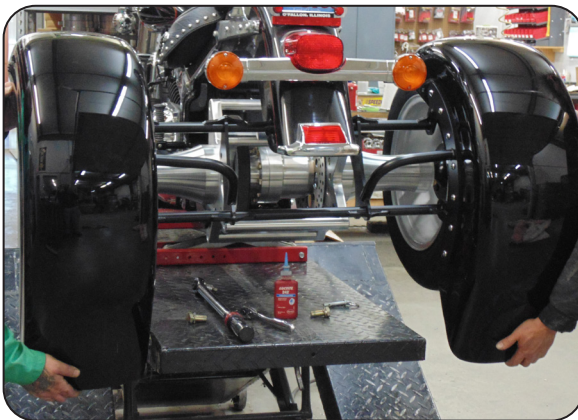

Depending on your kit you may have a different style axle housing and fender brackets

Install fender and bracket on the rear end with supplied hardware. Apply blue loctite. Torque fender bracket bolts to 45 ft. lbs. Repeat installation of fender and bracket for the other side of the trike.

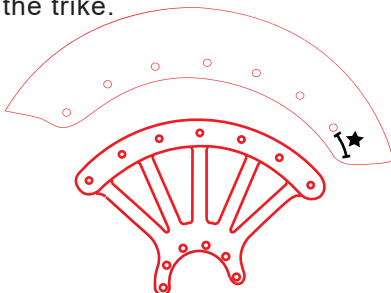

shown: left bracket and fender



22. Tighten lug nuts on rear wheels torque 78 to 85 ft. lbs. and go for a ride. Re-torque lug nuts after 25 miles or 100 mile maximum.



Tip: Recommended tire pressure is 25psi.



Note: Initially the brake and rotor need to be worn in before maximum braking can be achieved. Please use caution.

Our Trike rear ends are made from all 6061 T6 billet aluminum, except for our Light Sport Std. Trike rear end, which has 3/8" thick steel star plates, powder coated silver, instead of 1" thick billet aluminum star plates that we use on all our other Trike rear ends.

All of our rear ends have a Dana 30 differential, packed with Moly EP grease. 9" Ford street/strip axles with a bolt pattern of 5 studs on 4 1/2" bolt circle, wheel studs are 1/2"-20. HHI/Frankenstein 4 piston billet caliper, 11 1/2" stainless steel brake rotor, or optional outboard Brakes with two HHI/Frankenstein 4 piston billet calipers and two 11" stainless steel brake rotors. We only use top quality new parts in our manufacturing of "Frankenstein Trikes" rear ends.

Replacement Parts

Differential seal: National oil seal # 481213 \$12.00 each

Differential Bearing: # 62102RS \$24.00 each

Axle Bearing: BCA # RW207-CCRA \$65.00 each

Brake Pads: HHI-101-001 \$39.00 pair

prices subject to change